

NORclad® PROFILE SHEET

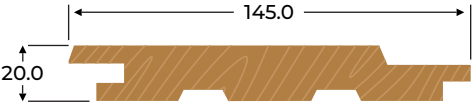

NORclad[®]
Part of National Timber Group



NWC1
RECOMMENDED FOR BRUNNEA REDWOOD,
EUROPEAN LARCH AND THERMOWOOD
(AVAILABLE 142MM WIDE)

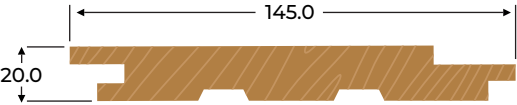

NWC2
RECOMMENDED FOR BRUNNEA REDWOOD,
EUROPEAN LARCH AND THERMOWOOD
(AVAILABLE 142MM WIDE)

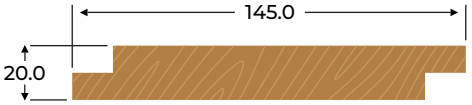

NWC4

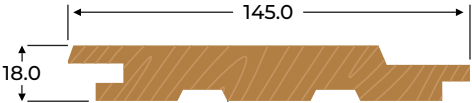

NWC1 18MM
RECOMMENDED FOR WESTERN RED CEDAR

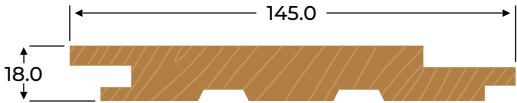

NWC2 18MM
RECOMMENDED FOR WESTERN RED CEDAR

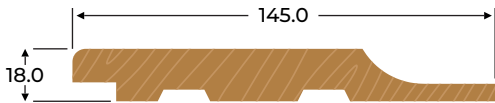

NWS1

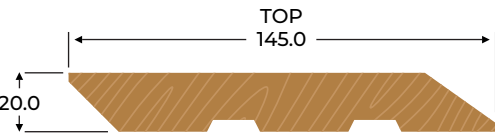

NWCC1

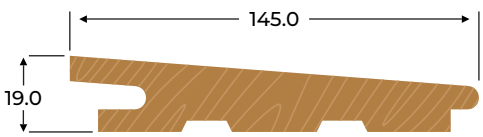

NWFE2-19

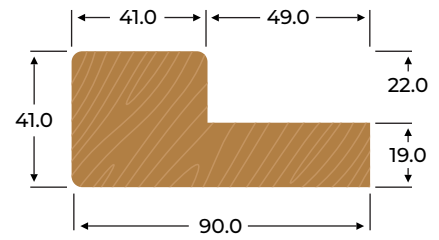

NWPA6

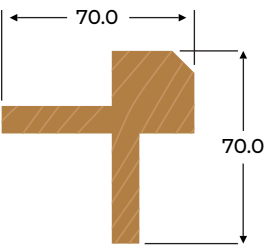

NWA1

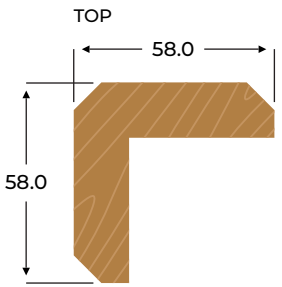

NWA3

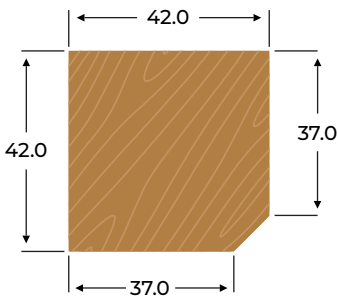

NWA4
ALSO AVAILABLE WITH
ROUNDED CORNERS FOR
COATED CLADDING

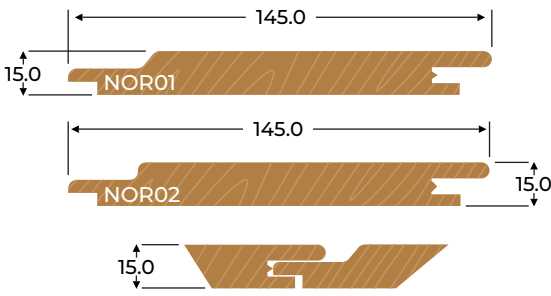

NOR01 & NOR02
ACCOYA ONLY AND SUITABLE FOR COATING